

# Network High Speed Dome Quick Setup Guide

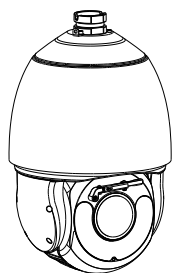

NO:101-500-0282-01  
Issue:1.0

## Precautions

Fully understand this document before using this device, and strictly observe rules in this document when using this device. If you install this device in public places, provide the tip "You have entered the area of electronic surveillance" in an eye-catching place. Failure to correctly use electrical products may cause fire and severe injuries.

<b>WARNING</b>	It alerts you to moderate dangers which, if not avoided, may cause minor or moderate injuries.
<b>CAUTION</b>	It alerts you to risks. Neglect of these risks may cause device damage, data loss, device performance deterioration, or unpredictable results.
<b>NOTE</b>	It provides additional information.

### **WARNING**

- Strictly observe installation requirements when installing the device. The manufacturer shall not be held responsible for device damage caused by users' non-conformance to these requirements.
- Strictly conform to local electrical safety standards and use power adapters that are marked with the LPS standard when installing and using this device. Otherwise, this device may be damaged.
- Use accessories delivered with this device. The voltage must meet input voltage requirements for this device.
- If this device is installed in places with unsteady voltage, ground this device to discharge high energy such as electrical surges in order to prevent the power supply from burning out.
- When this device is in use, ensure that no water or any liquid flows into the device. If water or liquid unexpectedly flows into the device, immediately power off the device and disconnect all cables (such as power cables and network cables) from this device.
- Do not focus strong light (such as lighted bulbs or sunlight) on

this device. Otherwise, the service life of the image sensor may be shortened.

- If this device is installed in places where thunder and lightning frequently occur, ground the device nearby to discharge high energy such as thunder strikes in order to prevent device damage.
- The laser from the laser high speed camera can not directly face the human eyes to avoid possible damage to the human eyes.
- Laser high-speed cameras' lasers may cause fire hazards when directly facing flammable objects within short distance, Please keep a certain safe distance during installation.

### **CAUTION**

- Avoid heavy loads, intensive shakes, and soaking to prevent damages during transportation and storage. The warranty does not cover any device damage that is caused during secondary packaging and transportation after the original packaging is taken apart.
- Protect this device from fall-down and intensive strikes, keep the device away from magnetic field interference, and do not install the device in places with shaking surfaces or under shocks.
- Clean the device with a soft dry cloth. For stubborn dirt, dip the cloth into slight neutral cleanser, gently wipe the dirt with the cloth, and then dry the device.
- Do not jam the ventilation opening. Follow the installation instructions provided in this document when installing the device.
- Keep the device away from heat sources such as radiators, electric heaters, or other heat equipment.
- Keep the device away from moist, dusty, extremely hot or cold places, or places with strong electric radiation.
- If the device is installed outdoors, take insect- and moisture-proof measures to avoid circuit board corrosion that can affect monitoring.
- Remove the power plug if the device is idle for a long time.
- Before unpacking, check whether the fragile sticker is damaged. If the fragile sticker is damaged, contact customer services or sales personnel. The manufacturer shall not be held responsible for any artificial damage of the fragile sticker.

## Special Announcement

- All complete products sold by the manufacturer are delivered along with nameplates, quick setup guide and accessories after strict inspection. The manufacturer shall not be held responsible for counterfeit products.
- The manufacturer will update this manual according to product function enhancement or changes and regularly update the software and hardware described in this manual. Update information will be added to new versions of this manual without prior notice.
- This manual may contain misprints, technology information that is not accurate enough, or product function and operation description that is slightly inconsistent with the actual product, the final interpretation of company is as a standard.
- This manual is only for reference and does not ensure that the information is totally consistent with the actual product. For consistency, see the actual product.

### **NOTE**

For more information, please refer to website.

## 1 Open Package Examination

Open the package, check the appearance of product for no obvious damage, and confirm the item list for table 1-1 is consistent.

Table 1-1 Packing list

Component	Quantity	Remark
High Speed Dome Camera	1	
Quick Setup Guide	1	
Power adapter	1	
Power wire	1	
A pair of gloves	1	
Wall mount bracket	1	Optional
L Wrench	1	
Stainless hexagon screw	3	
Plastic anchor	4	

## 2 Device Structure

### 2.1 Device Ports

#### **NOTE**

Different devices may have different multi-head cables; Please refer to the actual product.

Figure 2-1 Multi-head cables

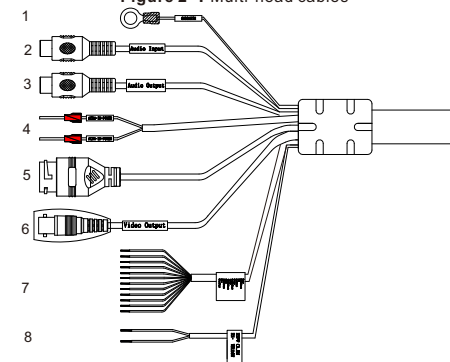

Table 2-1 Multi-heads cable description

ID	Core	Function	Description
1	Yellow green	Grounding wire	Connect to ground.
2		Audio input	Receive an analog audio signal from devices such as a sound pickup device
3		Audio output	Connect to an external audio device such as a speaker.
4		Supply power	Connect to DC36V
5		Network interface	Connect to a standard Ethernet cable.
6		Video out	Send a CVBS analog signal.
7	Brown	Alarm output 1	Alarm input and alarm output ports.
	Brown black	Alarm output 1 com	
	Red	Alarm output 2	
	Red black	Alarm output 2 com	
	Orange	Alarm input 1	
	Orange black	Alarm input 2	
	Yellow	Alarm input 3	
	Yellow black	Alarm input 4	
	Green	Alarm input 5	
	Green black	Alarm input 6	
	Blue	Alarm input 7	
	Blue black	Alarm input com	
8	Green	RX+	Connect to RS 485.
	Yellow	RX-	

## 2.2 Camera Dimensions

#### **NOTE**

Different devices may have different dimensions; Please refer to the actual product.

Figure 2-2 Dimensions (Unit: mm)

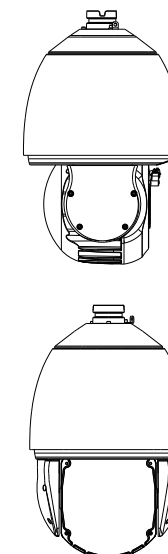
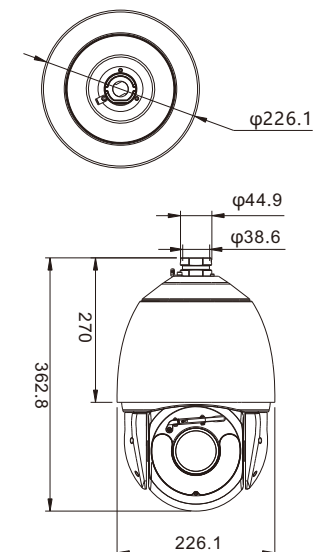
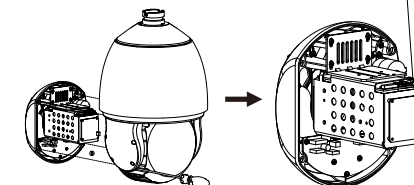
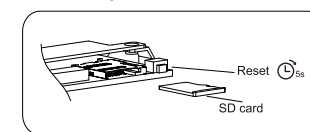

Figure 2-3 Installing SD card



Loose the four screws  
take out the device core

### 3 Device Installation

#### Installation Steps:

Step 1 Please make the mark based on bracket dimensions for drilling the hole. Drill four φ8 holes over 60 mm depth, and drive the plastic anchors into the holes. Fixed bracket with screws. Connect the connector to bracket as shown in figure 3-1.

Figure 3-1 Fixing bracket

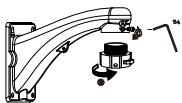

Step 2 Hang the camera body to bracket with security rope to prevent falling. Thread all cables through the cable hole on the side of the bracket, fix camera body with screws as shown in the figure 3-2.

Figure 3-2 Fixing camera

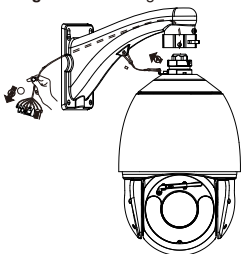

Step 3 Connect the multi-head cables. Remove the plastic membrane, as shown in figure 3-3.

Figure 3-3 Connecting multi-head cables

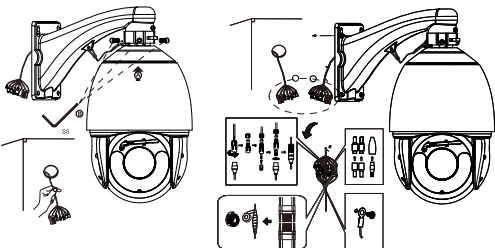
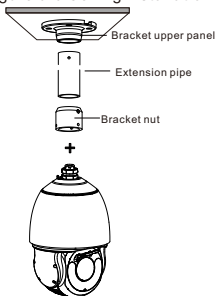

Figure 3-3 Ceiling installation



#### NOTE

- Users can choose different brackets to install, such as corner mount bracket, pendent mount bracket, junction box and so on.
- If the high-speed camera is a laser camera, the laser can't directly face the human eyes, and it can't illuminate directly the flammable object. It needs to keep a certain safe distance to avoid fire.

### 4 Quick Configuration(e.g IE)

#### 4.1 Login

Step 1 Open the Internet Explorer, enter the IP address of IP camera (the default value: 192.168.0.120) in the address box, and press Enter. The login page is displayed as shown in figure 4-1.

Step 2 Input the user name and password.

#### NOTE

- The default user name and password are both admin. Change the password when you login the system for the first time to ensure system security.
- It is advised to restart the device three minutes later after modifying password.
- You can change the system display language on the login page.

Figure 4-1 Login

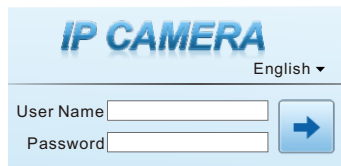

Step3 Click Login, the main page is displayed.

#### 4.2 Modify IP address

Choose **Configuration > Device > Local Network**, the **Local Network** page is displayed. Input the IP address in the IP Address box and click **Apply** as shown in figure 4-2.

After the IP address is set successfully, please use the new IP address to login the Web interface.

Figure 4-2 Local Network

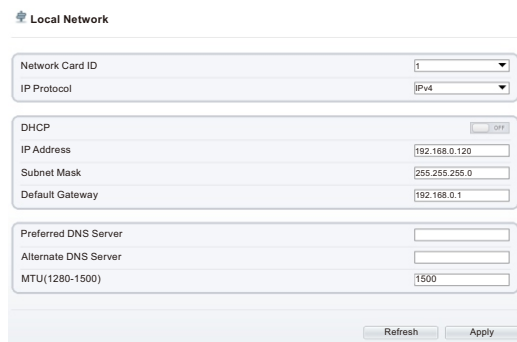

#### 4.3 Browsing Video

To ensure the real-time video can be played properly, you must perform the following operation when you login the web for the first time. If you can view the video immediately, please ignore it.

Step 1 The Internet Explorer. Choose **Tools > Internet options > Security > Trusted sites > Sites**, in the display dialog box, click **Add**, as shown in figure 4-3.

Step 2 In the Internet Explorer, choose **Tool > Internet Options > Security > Customer level**, and set **Download unsigned ActiveX control and initialize and script ActiveX controls not marked as safe for scripting under ActiveX controls and plug-ins to enable**, as shown in figure 4-4.

Figure 4-3 Adding a trusted site

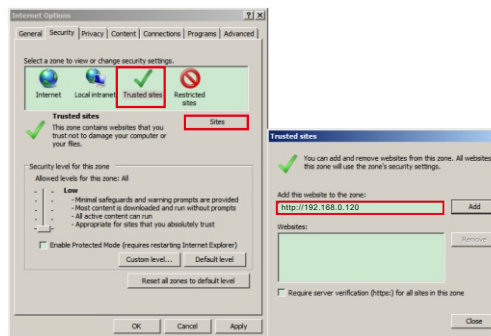
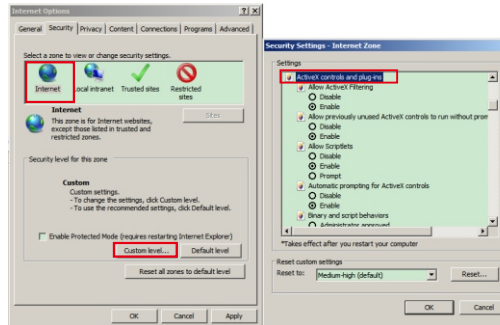

Figure 4-4 Configuring ActiveX control and plug-ins



Step 3 Download and install the player control as prompted.

#### NOTE

If the repair tips displayed when installing the control, please ignore the prompt, and continue the installation, close the Web page during installing. Then login the page again.

To browse a real-time video, login the device and click **Live Video**. The Live Video page is displayed, as shown in figure 4-5.

Figure 4-5 Live Video

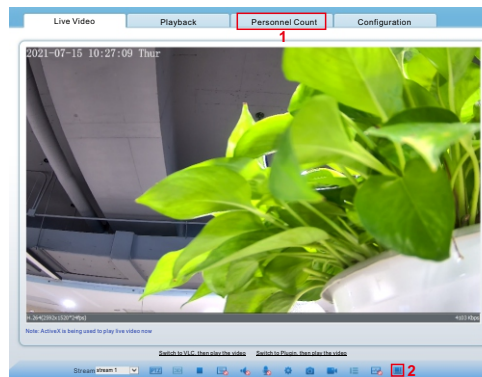

1 Personnel Count: Users can query the data of personnel count, through year, month, day. The statistics can be downloaded. The data can be shown by line chart, histogram, list.

2 AI Live video: Click the icon to view the snapshots of human face or license plate (click "Face" or "Plate" to switch ). The bottom page will show the captured images of vehicle and human .

Figure 4-6 Installation of personnel count

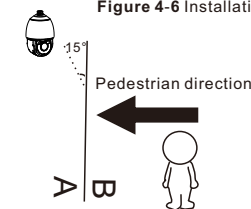

#### CAUTION

If the user requires higher accuracy of personnel count, we recommend the user to install camera and draw the line following as figure 4-6.

#### 4.4 Two-way audio

##### NOTE

Partial cameras do not support two-way audio, this section does not apply.

##### 4.4.1 Camera ↔ PC

Connection:  
Step 1 Connect microphone to audio input interface of camera.  
Step 2 Connect speaker to the PC audio output interface.  
Step 3 Log in camera Web, click to turn on two-way audio.

##### 4.4.2 PC ↔ Camera

Step 1 Connect microphone to PC audio input interface.  
Step 2 Connect speaker to camera audio out interface.  
Step 3 Log in camera Web, click to turn on two-way audio.

#### 4.5 Intelligent Analysis

At "Configuration > Intelligent Analysis" interface, users can set the parameters of Perimeter, Single Virtual Fence, Double Virtual Fence, Multi Loiter, Converse and Personnel Count, as shown in figure 4-7.

Figure 4-7 Intelligent Analysis

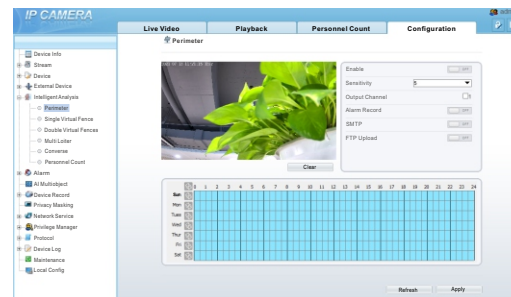

#### 4.6 AI Multi object

At "Configuration > AI Multi object" interface, users can enable face detection, full body detection, vehicle detection, set the other parameters of detection, as shown in figure 4-8.

Figure 4-8 AI Multi object

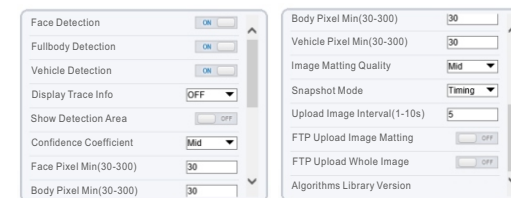

#### NOTE

For better capture performance, it is recommended to use 6mm focus length lens or above.